

OPERATING GUIDE FOR YOUR MAGNUM ALERT-700 SECURITY SYSTEM

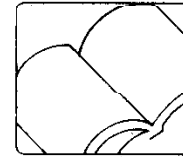

© Napco 1984

www.BevanSecurity.Com

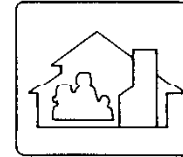

CONGRATULATIONS

Congratulations. You have taken a major step in protecting your safety and valuables by having a Napco MAGNUM ALERT-700 Alarm Control Center installed on your premises.

We encourage you to read this booklet and to thoroughly familiarize yourself with your new security system. If you have any questions contact your alarm specialist.

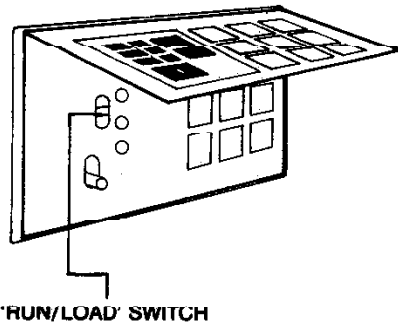

'RUN/LOAD' SWITCH

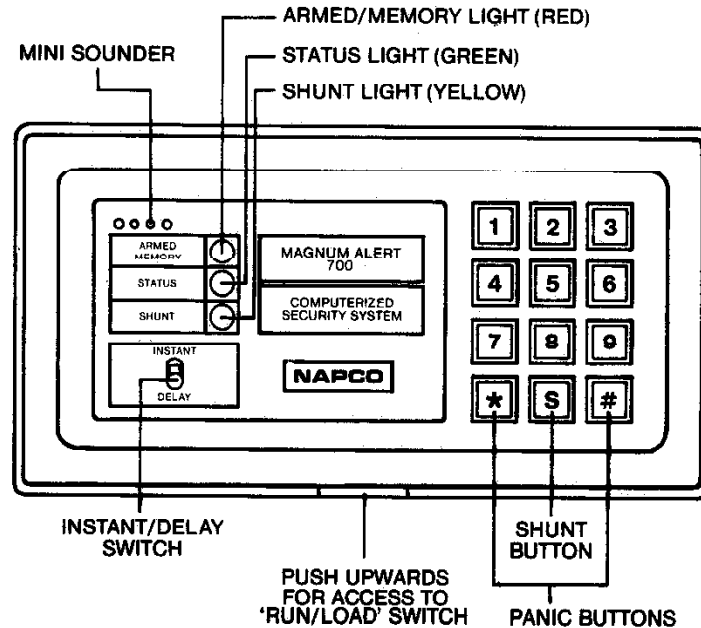

GLOSSARY OF TERMS



Alarm Plan

(See page 10.) Identifies the areas of your premises protected by each zone location and lists zone features. To be filled in and explained by your alarm specialist.

Armed/Memory Light

Located on Napco's Digit-key keypad or optional keyswitch. Steady red light indicates system is armed; flashing red light warns an alarm occurred while you were away.

Arming/Disarming

Turning your system on or off by entering code on Napco's Digit-key keypad or turning an optional keyswitch.

Battery

Standby battery is placed in the Control Center box to provide backup protection in the event of a power loss.

Central Station

Monitors incoming burglary, fire and emergency messages from a Digital Communicator, and alerts police or fire authorities.

Control Center

The heart of the Magnum Alert-700 security system; it controls all system functions.

Digital Communicator

Reports fire, burglary, and medical emergencies directly to Central Station over telephone lines.

Digital Keypad

Napco's Digit-key keypad puts Control Center functions at your fingertips either at Control Center or in a remote location.

Exit/Entry Delay

Lets you exit and enter your premises without setting off an alarm after the system is armed.

Mini-Sounder

Buzzer at each Napco Digit-key keypad warns that entry delay time is up. It also sounds when you attempt to arm the system when a particular zone is in "trouble."

Panic Buttons

Two buttons (* and #) on the Digit-key keypad activate the Digital Communicator to alert the Central Station of an emergency.

Shunt Button

Labeled "S" on the Napco Digit-key keypad. Lets you manually remove one or more protective zones from the system.

Shunt Light

Amber light on Napco Digit-key keypad indicates you have armed the Control Center with zone(s) manually removed from the system.

Status Light

Green light on the Napco Digit-key keypad. A steady green light tells you it is okay to turn on the system. A flashing light warns of a zone in "trouble" before arming.

Zones

Independent circuits which protect specific areas of your premises. Zone locations and features should be listed on the Alarm Plan on the back of this operating guide and thoroughly explained by your installer.

Zones (24 Hour): A 24 hour zone is always armed and ready at all times to respond to an emergency situation.

Zones (Burglary): Zones that detect intrusion.

Trouble Zone(s): Zone(s) that cannot be armed because of an open window, door, or other problem in the area.

Priority Zone(s): When a zone(s) selected for the feature is in "trouble" it will be impossible to arm the Control Center.

Auto Shunt: Allows you to arm the Control Center even though selected zones are in "trouble".

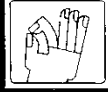

UNDERSTANDING YOUR SECURITY SYSTEM

Each security system is custom tailored to the owner's needs, but all MAGNUM ALERT-700's have the same basic components.

1 Burglary protection circuits

There are four Burglary PROTECTIVE CIRCUITS ("zones"), plus an extra Auxiliary zone which may be used for fire protection where permitted by local ordinance. (See "FIRE PROTECTION".) Each zone is an independent circuit that protects specific areas of your home. For example: your alarm specialist may have set aside one zone for window protection; another, with exit/entry delay, for the most frequently used doors; and the remaining zones for general protection. Make sure you know what each zone protects.

2 Digital keypad arming stations

DIGITAL KEYPAD ARMING STATION is provided from which you will arm and disarm the system; check the condition ("status") of each zone; temporarily remove from the system ("shunt") individual zones; send a "panic" or hold-up, alert. Each station has a Mini-Sounder that will sound if you try to arm the system when a particular zone is in "trouble" (incapable of being armed) or experiences an alarm, and the green STATUS light will flash to indicate which zone or zones require attention. The red ALARM/MEMORY light shows whether your system is armed. The Mini Sounder will also warn as you enter that you will cause an alarm if you do not reset the control center before the end of your entry time period.

3 The alarm circuit

The ALARM CIRCUIT is activated by any of the zones set aside for burglary, fire or medical attention. When the Alarm Control Center senses an "alarm condition" from any of these sources it responds by either sounding an audible alarm or alerting a remote central station, or both. Your alarm specialist has designed your system to react in a specific manner for each type of emergency. Be sure you understand how your system will respond in each type of emergency condition.

USING YOUR SECURITY SYSTEM



The keypad

You will arm and disarm from the built-in keypad. You will use your own personal code to do this. (See "CODE ENTRY".) The green STATUS light will be on when all four burglary protection zones are "good". It will flash if any burglary zones are in "trouble". The red ARMED/MEMORY light goes on to show your system is armed, and off to show it is disarmed. If you enter the wrong code your alarm system will not arm or disarm and the light will fail to respond. Wait 5 seconds before trying again to enter your code. The red light will flash if an alarm occurs while the system is armed. The amber SHUNT light will light whenever the system is armed with a zone, or zones, manually shunted using the SHUNT button.

Code entry

Your system cannot be disarmed by unauthorized persons. It responds only when a code of your choosing is entered through the keypad.

Selecting your code the first time

After your alarm specialist installs your system, he will show you how to customize it with your own personal code. First, he will show you the RUN/LOAD switch located through a hole beneath the cover plate of your control unit. Use a pencil or a toothpick to carefully slide this switch to the LOAD position (down).

Go to the keypad and enter any combination of 3 to 6 digits. There is no zero digit. Use a number you will remember, such as your birth-

day(12-5-47). Do not use something obvious like your address. The numbers you press will be your code.

Go back to the control unit and put the RUN/LOAD switch in the RUN position. Your protection system will not work when this switch is in the LOAD position. Always leave the switch in the RUN position.

Changing your code

To change the personal code recognized by your system: Use a pencil or toothpick to set the RUN/LOAD switch (see page 2) as follows:

- 1) Put RUN/LOAD switch in LOAD position.
- 2) Enter new code from keypad.
- 3) Put RUN/LOAD switch in RUN position.

Reminder: When arming or disarming, if the red light does not respond, you may have entered the wrong code. Wait 5 seconds before trying again to enter your code.



PROTECTING YOUR PREMISES WHILE YOU ARE AWAY

Arming the system before you leave

First, check the green STATUS light at the keypad. If this light is on steadily, enter your code. The red ARMED/MEMORY light will come on and the green lamp will go out. Leave immediately through the entry/exit delay doorway before the delay time runs out. If you delay too long in leaving the premises, you will hear the Mini-Sounder warn you that the exit delay time has run out. To avoid causing an alarm, quickly return to the keypad and enter your code to reset the control center. You may then rearm and try to exit again.

Arming with a zone in "trouble"

When the green STATUS light is flashing, one or more of your burglary protection zones are in "trouble". The green light will

flash the number(s) identifying the zone or zones in "trouble". For example, if your back door is open on Zone 1 and a window is open on Zone 3, the green STATUS lamp will flash once for Zone 1, pause, then flash three times for Zone 3. (Refer to your Alarm Plan for zone locations.)

Look for something you can fix yourself in the area protected by the zone(s) in "trouble". In this example, you can fix the zone yourself by closing the back door and the window.

If the Zone cannot be fixed immediately, the green light will continue to flash. Try to arm. If the zone(s) in "trouble" have been programmed as Auto-shunt zones, the red ARMED/MEMORY lamp will come on, the green light will go out, and your system will be armed. The sounder will come on for 3 seconds to remind you that you armed with one or more zones shunted (turned off).

When you try to arm with a zone programmed as a "Priority"

zone in "trouble", the control center will not arm. Enter your code again to silence the sounder. If you cannot fix the zone, call your alarm specialist.

Check the Alarm Plan in this manual to remind you which zones are programmed as Priority zones and which are Auto-shunt.

The Alarm Plan will also indicate which zones, if any, can be manually shunted. Manually shunt with caution. Shunting too many zones will leave your premises unprotected, even with your system armed. To arm with zone(s) manually shunted, count the flashes on the green STATUS light to be sure the zone in "trouble" is capable of being manually shunted. Press the SHUNT button, labeled "S", and enter your code. The yellow SHUNT light and the red ARMED/MEMORY light will come on. The green light will be out. All zones programmed by your alarm specialist to respond to manual shunting will be shunted (even if some are not in "trouble").



Leave quickly when the red ARMED/MEMORY light goes on.

Be sure to have all zones in "trouble" repaired as soon as possible.

Disarming when you return

When you enter through the exit/entry delay door, the entry delay Mini-Sounder will come on.

Check the red ARMED/MEMORY light. If it is flashing, an alarm occurred while you were gone. Disarm the system with your code from the keypad to silence the sounder. NOTE: If your system has a digital communicator, there may be a delay while it is reporting an alarm before your system disarms.

If the red ARMED/MEMORY light was flashing before you disarmed, it will go out briefly then begin to flash a number of pulses identifying the zone(s) that had an alarm. Write down the number of

times the alarm memory lamp flashes, so you will have a record of which zone(s) need attention. You may then arm and disarm to cancel the flashing alarm memory. If a zone is still in alarm condition, you will hear the Mini-Sounder for three seconds. The red ARMED/MEMORY light will go out. The green STATUS light may start flashing if zones are still in "trouble" from the alarm.

If there was an alarm and the red ARMED/MEMORY light did not flash, the alarm was a 24 Hour Zone (see your Alarm Plan). The cause of the alarm will have to be removed before you can clear the alarm signal.

If a fire protection system has been installed, follow the included instructions to clear a smoke detector alarm.



PROTECTING YOURSELF WHILE YOU ARE ON PREMISES

Arming with zone shunting

You might have chosen one or two zones that you can manually "shunt out" of the system from the keypad. A shunted (bypassed) zone cannot cause an alarm. Zone shunting may be used for turning off interior protection, or allowing you to turn on only your perimeter protection.

To arm with zone(s) shunted, first check the green STATUS lamp to make sure that no perimeter zone is in "trouble". Then

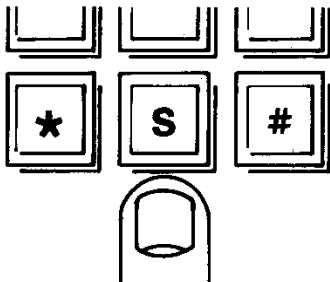

press the SHUNT button, labeled "S", and enter your code. The yellow SHUNT light and the red ARMED/MEMORY light will come on. The green light will be out. The SHUNT light will go out when you disarm the control center.

Alarm with the system disarmed

If an alarm signals at a time when your system is not armed, an alarm is occurring on a 24 hour protection zone, or your standby battery is low. The cause of the alarm must be corrected and then the control center reset by arming and disarming again in order to clear the signal. (Consult your Alarm Plan to determine which, if any, of your protection zones are 24 hour).

Cancelling entry/exit delay

Your alarm Control Center is fitted with an INSTANT/DELAY switch. This switch can be used to cancel the entry/exit delay for your doors. You might want to put this switch in the INSTANT position before arming when you are remaining inside. When this switch is set to the INSTANT position, all your protection zones will react immediately in an alarm situation.

Remember to reset the INSTANT/DELAY SWITCH to DELAY before arming when leaving.

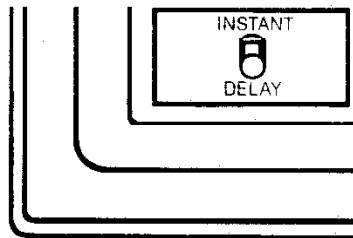

PANIC ALARM

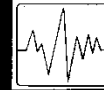

Panic alarm

To activate a panic alarm and call for outside help, press the two buttons marked * and # on the Digit-key keypad. ***Make sure you press both buttons at the same time.*** The panic zone is capable of sending a silent signal to the Central Station when a Digital Communicator is being used.

The Panic alarm is always active, whether your eyetem is armed or not.

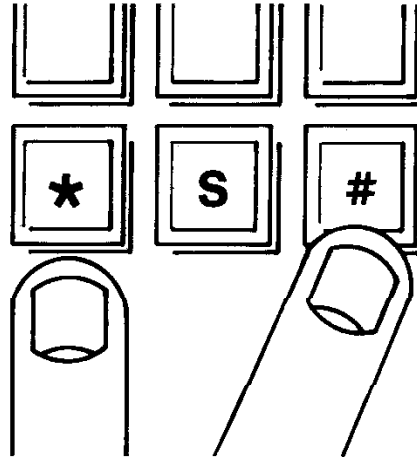



ALARM PLAN

Zone	Area Protected	Zone Features	Contacts (doors, windows, etc.)
1			
2			
3			
(Panic) (5)			
Aux. (6)			

Central Station # _____ Telephone # _____
 Service Person _____ Telephone # _____

* optional feature

Napco limited warranty

NAPCO SECURITY SYSTEMS, INC. (NAPCO) warrants each of its products to be free from manufacturing defects in materials and workmanship for fifteen months following the date of manufacture. NAPCO will, within said period, at its option, repair or replace any product failing to operate correctly, without charge to the original purchaser or user.

This warranty shall not apply to any equipment or any part thereof which has been repaired by others, improperly installed, improperly used, abused, altered, damaged, subjected to accident, nuisance flood, fire or acts of God, or on which any serial numbers have been altered, defaced or removed. Seller will not be responsible for any dismantling, reassembly or reinstallation charges.

In order to exercise the warranty, the product must be returned by the user or purchaser, shipping costs prepaid, and insured to NAPCO at its offices at 6 DiTomas Court, Copiague, New York. After repair or replacement, NAPCO assumes the cost of returning products under warranty.

There are no warranties, express or implied which extend beyond the description of the facts hereof. There is no express or implied warranty of merchantability or a warranty of fitness for a particular purpose. Additionally, this warranty is in lieu of all other obligations or liabilities on the part of NAPCO.

This warranty contains the entire warranty. It is the sole warranty and any prior agreements or representation, whether oral or written, are either merged herein or are expressly cancelled. NAPCO neither assumes, nor authorizes any other person representing it and on its behalf to warrant, to change, nor to assume for it, any other warranty or liability concerning its products.

In no event shall NAPCO be liable for an amount in excess of NAPCO's original selling price of the product, for any commercial loss or damage, whether direct, indirect, incidental, consequential, or otherwise arising out of any failure of the product.

Seller's warranty, as hereinabove set forth, shall not be enlarged, diminished or affected by, and no obligation or liability shall arise or grow out of Seller's rendering of technical advice or service in connection with Buyer's order of the goods furnished hereunder.

NAPCO recommends that the entire system be completely tested weekly.

Warning: Despite frequent testing, and due to, but not limited to, any or all of the following: criminal tampering, electrical or communications interruption, it is possible for the system to fail to perform as expected. Therefore, the consumer is advised to take any and all precautions for his or her safety including, but not limited to, leaving the premises and calling police or fire department, in order to mitigate the possibilities of harm and/or damages.

This warranty shall be construed in accordance with the laws of the State of New York.



Napco Security Systems, 6 DiTomas Court, Copiague, New York 11726

www.BevanSecurity.Com

FIRE PROTECTION



Where local ordinance permits use of your alarm control center for fire detection, your alarm installer may connect smoke detectors or thermostats to your system. You will then have a 24 Hour fire protection circuit that is always armed, even when your system is turned off.

Disarming after a fire alarm

If a fire should occur to activate the alarm, the Audible Fire warning will sound but there will not be any visual indication on the Control Center. The alarm may be reset by disarming the control center in the usual manner. If the Burglar Alarm system was disarmed when the Fire alarm occurred, it will be necessary to arm, then disarm using the code twice.

If the control center does not disarm after this procedure, following a Fire, there may still be smoke inside a smoke detector, or a thermostat may still be hot. Try again later.

IMPORTANT! - Read Carefully

Discuss these escape procedures with those who use the building.

(1) If the premises is a residence, sleep with the bedroom door closed. A closed door will hold back deadly smoke while you escape.

(2) When the fire alarm signals, escape quickly. Do not stop to pack.

(3) Test the door. If it is hot, use your alternate route through the window. If the door is cool, brace your shoulder against it

and open it cautiously. Be ready to slam the door if smoke or heat rush in. Crawl through smoke, holding your breath. Close the doors again on leaving to help prevent the fire from spreading.

(4) Go to your specific out-door meeting place, so you can see that everyone is safe.

(5) Assign someone to make sure nobody returns to the burning building.

(6) Call the fire department from a neighbor's telephone.



FIRE ESCAPE PLAN

Preparing an escape plan

Even with the most advanced fire alarm system, adequate protection requires an escape plan. To prepare your plan:

Draw floorplans of your building. (See sample). Show two exits: a front or back door and a window from each room. (Make sure the window works. You may need a special fire escape ladder if the window is high up.) Write down your outside meeting place.

Rehearse: (1) Everyone in their room with the doors closed.
(2) One person sounds the alarm.
(3) Each person tests his door.
(4) Pretend the door is hot and use the alternate escape exit.
(5) Everyone meet outdoors at the assigned spot.

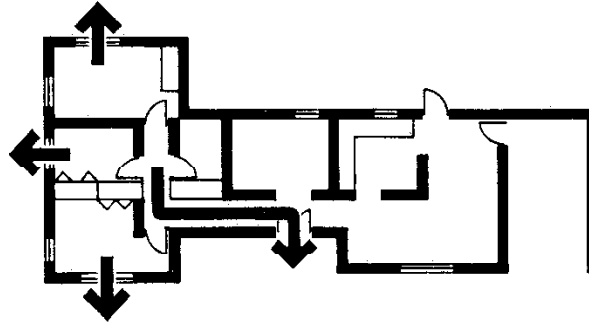

NAPCO

Napco Security Systems, 6 DiTomas Court, Copiague, New York 11726

OI - 101